



DONGGUAN XINGLIN ELECTRONICS CO.,LTD

SOD-323 Silicon Epitaxial Planar Diode

1SS355

FEATURES

- Small Surface Mounting Type:
SOD-323
- High Speed : $t=1.2\text{ns}$ Typ.
- High Reliability With High Surge Current Handling Capability.

APPLICATIONS

-

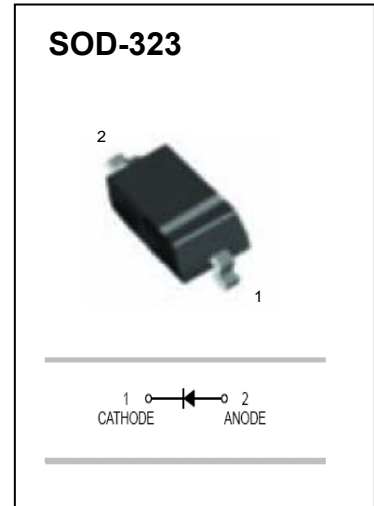

ORDERING INFORMATION

Type No.	Marking	Package Code
1SS355	A	SOD-323

MAXIMUM RATING @ $T_a=25^\circ\text{C}$ unless otherwise specified

Parameter	Symbol	Limits	Unit
Non-Repetitive Peak reverse voltage	V_{RM}	90	V
DC Reverse Voltage	V_R	80	V
Peak forward Current	I_{FM}	225	mA
Average Rectified Output Current	I_o	100	mA
Surge current (1s)	I_{surge}	500	mA
Junction temperature	T_j	125	$^\circ\text{C}$
Storage temperature	T_{STG}	-55~+125	$^\circ\text{C}$



ELECTRICAL CHARACTERISTICS @ Ta=25°C unless otherwise specified

Parameter	Symbol	Min.	Typ.	Max.	Unit	Conditions
Forward voltage	V_F			1.2	V	$I_F=100\text{mA}$
Reverse current	I_R			0.1	μA	$V_R=80\text{V}$
Capacitance between terminals	C_T			3	pF	$V_R=0.5\text{V}, f=1\text{MHz}$
Reverse Recovery Time	t_{rr}			4	ns	$I_F=10\text{mA}, V_R=6\text{V}, R_L=100\Omega$

TYPICAL CHARACTERISTICS @ Ta=25°C unless otherwise specified

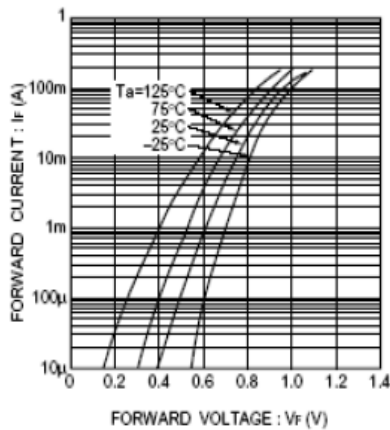

Fig.1 Forward characteristics

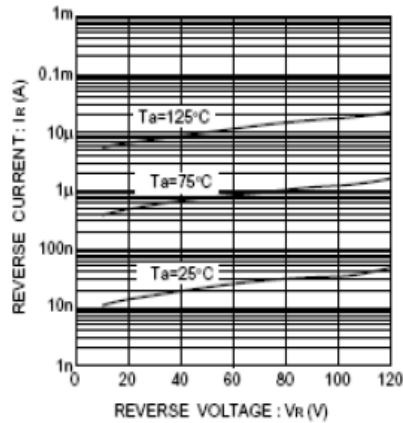

Fig.2 Reverse characteristics

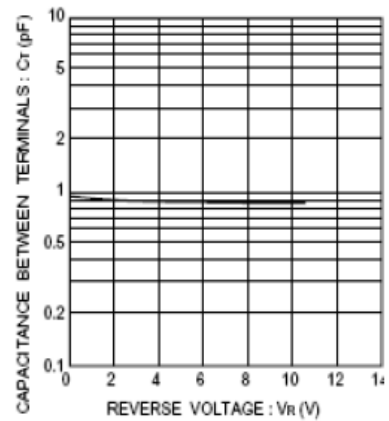

Fig.3 Capacitance between terminals characteristics

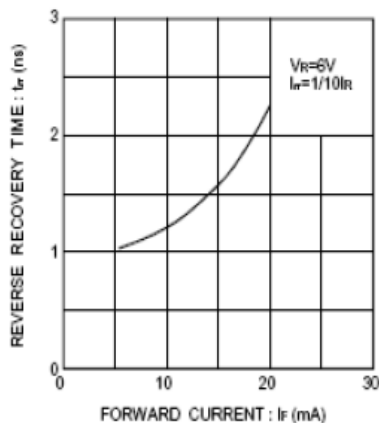

Fig.4 Reverse recovery time characteristics

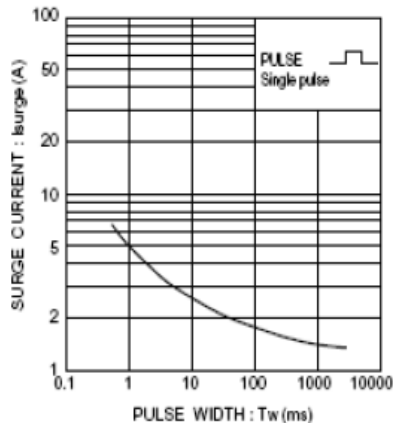

Fig.5 Surge current characteristics



PACKAGE OUTLINE

Plastic surface mounted package

SOD-323

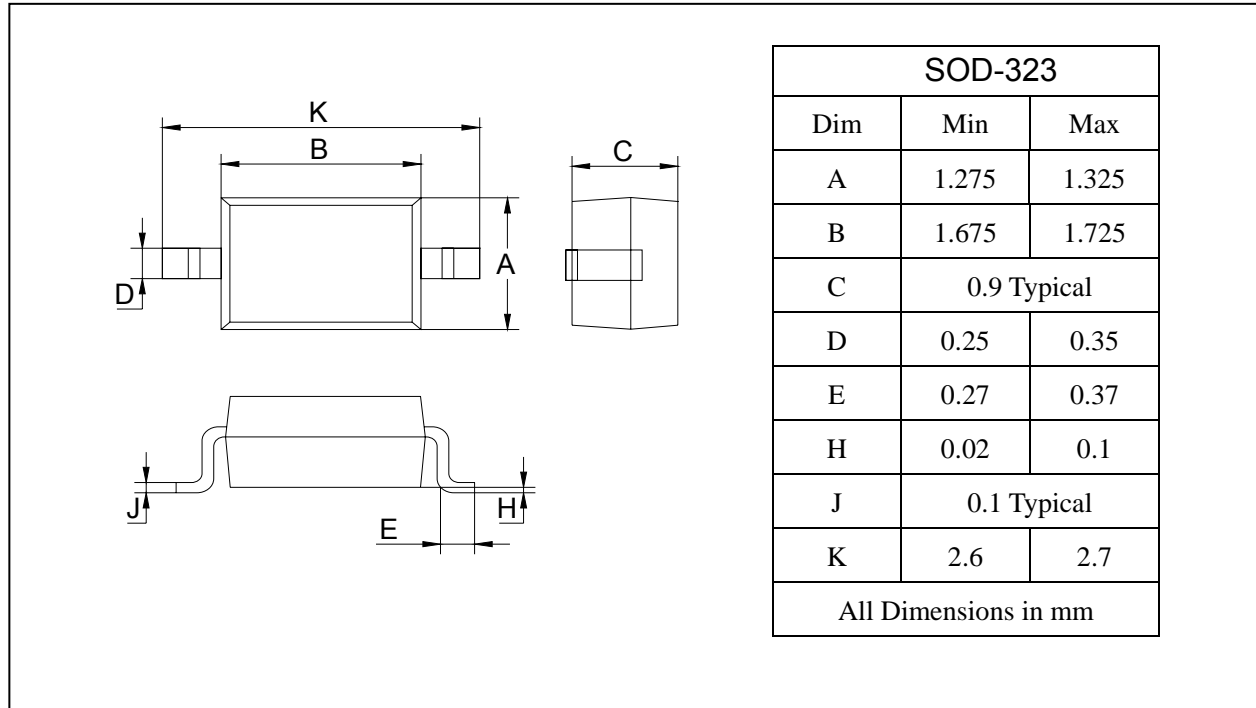

SOLDERING FOOTPRINT

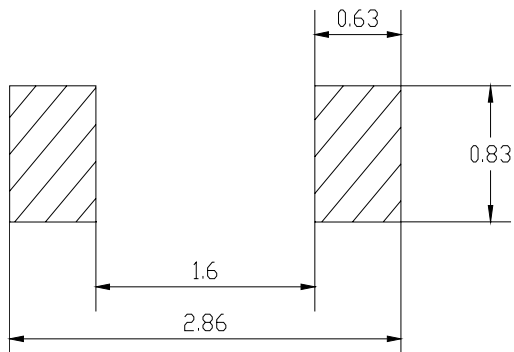

Unit : mm

PACKAGE INFORMATION

Device	Package	Shipping
1SS355	SOD-323	3000/Tape&Reel