

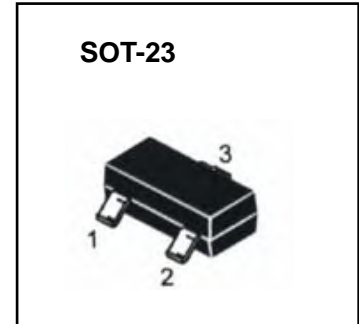

### BAS16

#### ■ Features

- Fast Switching Speed
- For General Purpose Switching Applications
- High Conductance

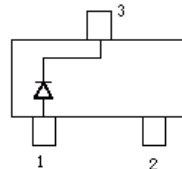

#### ■ Absolute Maximum Ratings Ta = 25°C

Parameter	Symbol	Rating	Unit
Non-Repetitive Peak Reverse Voltage	V <sub>RM</sub>	100	V
Peak Repetitive Reverse Voltage	V <sub>RRM</sub>		
Working Peak Reverse Voltage	V <sub>RWM</sub>	75	V
DC Blocking Voltage	V <sub>R</sub>		
RMS Reverse Voltage	V <sub>R(RMS)</sub>	53	V
Average Rectified Output Current	I <sub>O</sub>	200	mA
Forward Continuous Current	I <sub>FM</sub>	300	mA
Non-Repetitive Peak Forward Surge Current @ t = 1.0 μs	I <sub>FSM</sub>	2.0	A
@ t = 1.0s		1.0	
Power Dissipation	P <sub>d</sub>	250	mW
Thermal Resistance Junction to Ambient Air	R <sub>θJA</sub>	357	°C/W
Operating and Storage Temperature Range	T, T <sub>STG</sub>	-55 to +150	°C

#### ■ Electrical Characteristics Ta = 25°C

Parameter	Symbol	Test conditions	Min	Typ	Max	Unit
Reverse Breakdown Voltage	V <sub>(BR)R</sub>	I <sub>R</sub> = 100 μA	75			V
Forward Voltage	V <sub>F</sub>	I <sub>F</sub> = 1.0mA			0.715	V
		I <sub>F</sub> = 10mA			0.855	
		I <sub>F</sub> = 50mA			1.0	
		I <sub>F</sub> = 150mA			1.25	
Leakage Current	I <sub>R</sub>	V <sub>R</sub> = 75V			1.0	μA
		V <sub>R</sub> = 20V			25	nA
Junction Capacitance	C <sub>j</sub>	V <sub>R</sub> = 0, f = 1.0MHz			2	pF
Reverse Recovery Time	t <sub>rr</sub>	I <sub>F</sub> = I <sub>R</sub> = 10mA, I <sub>rr</sub> = 0.1 X I <sub>R</sub> , R <sub>L</sub> = 100 Ω			4	ns

#### ■ Marking

Marking	A6
---------	----



### Typical Characteristics

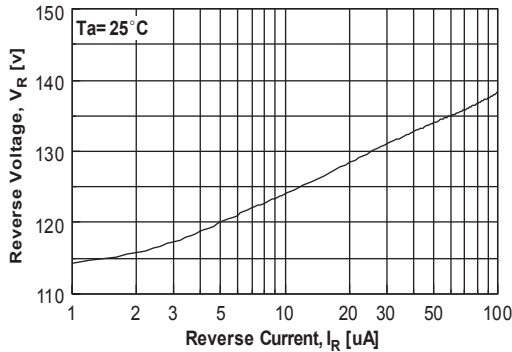

Figure 1. Reverse Voltage vs Reverse Current  
BV - 1.0 to 100 uA

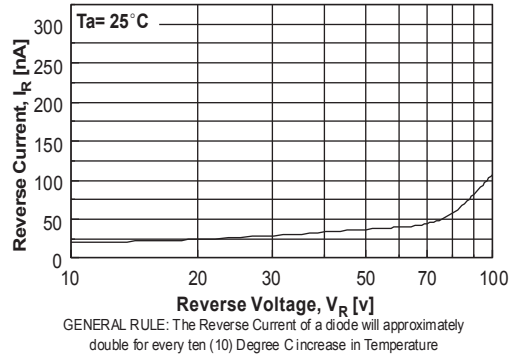

Figure 2. Reverse Current vs Reverse Voltage  
IR - 10 to 100 V

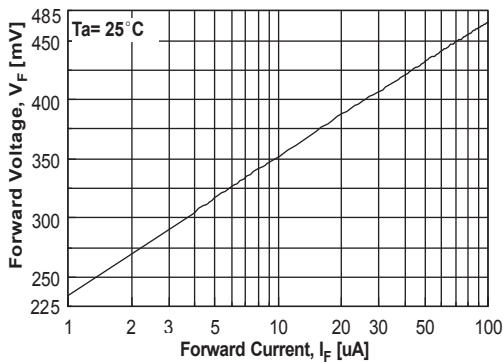

Figure 3. Forward Voltage vs Forward Current  
VF - 1.0 to 100 uA

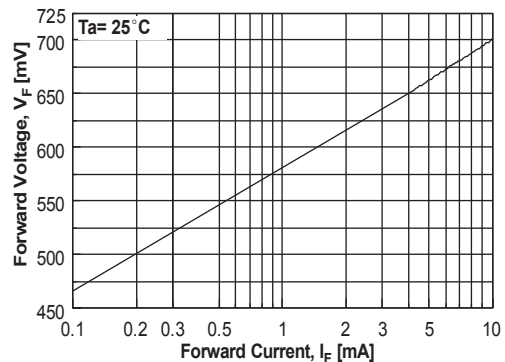

Figure 4. Forward Voltage vs Forward Current  
VF - 0.1 to 10 mA

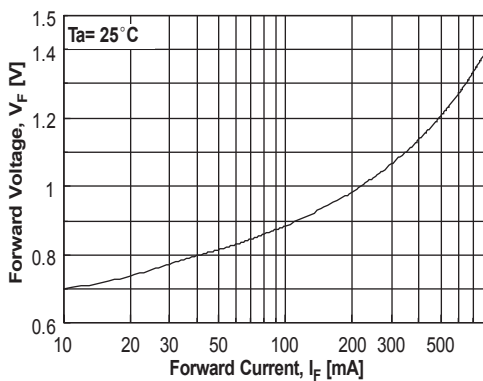

Figure 5. Forward Voltage vs Forward Current  
VF - 10 - 800 mA

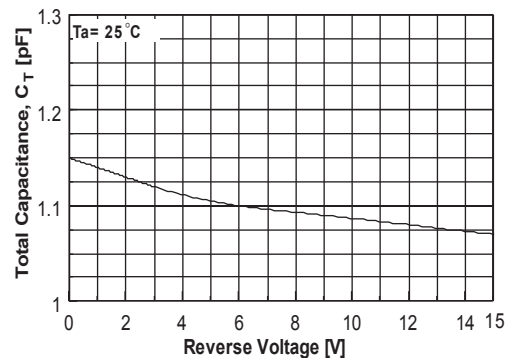
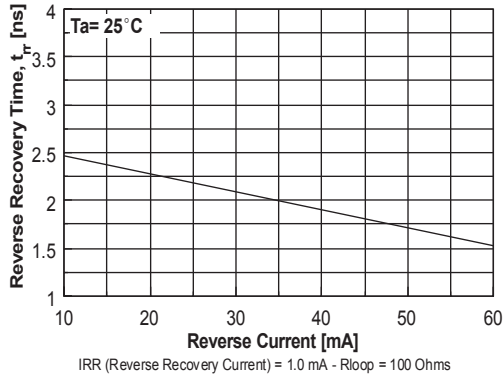

Figure 6. Total Capacitance



### Typical Characteristics



**Figure 7. Reverse Recovery Time vs Reverse Current**  
TRR - IR 10 mA vs 60 mA

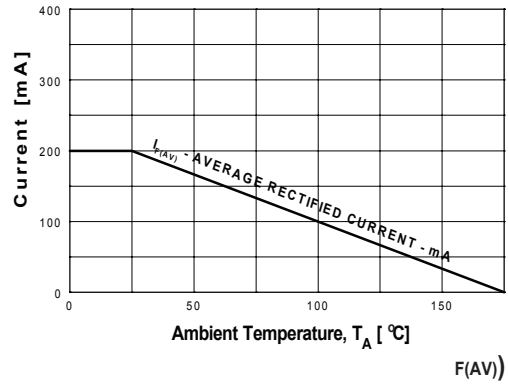

**Figure 8. Average Rectified Current (I<sub>A</sub>) versus Ambient Temperature (T<sub>A</sub>)**

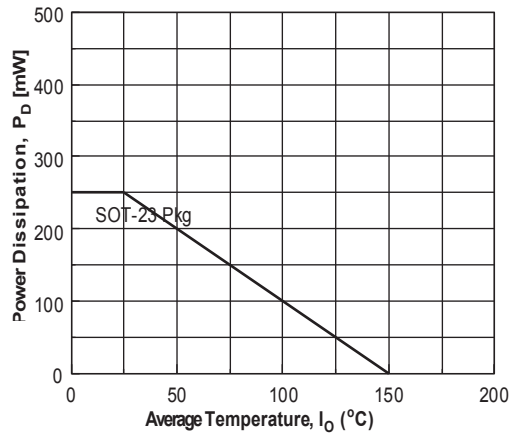

**Figure 9. Power Derating Curve**



Package Dimensions

SOT-23

unit:mm

